

Data Sheet

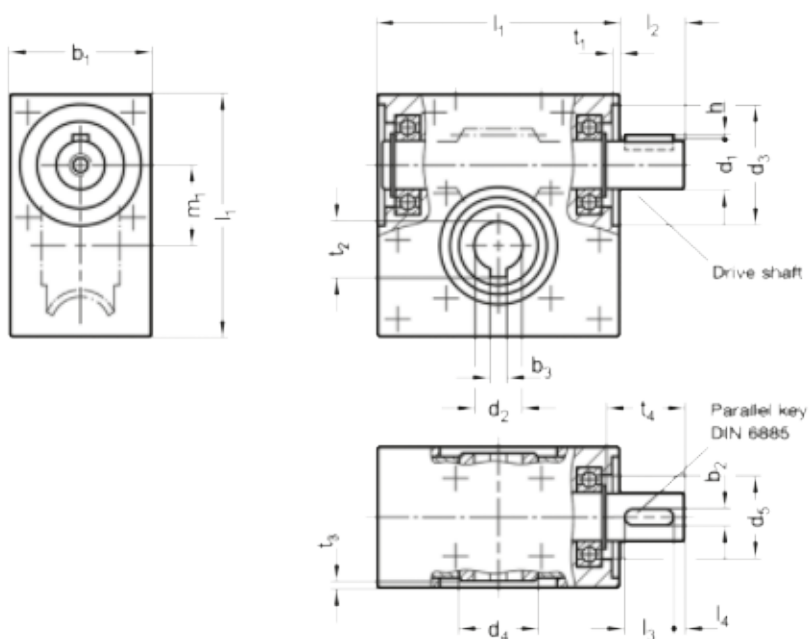

Article number: 20397520A1218AN
 Description: E+G Worm Gear Reducer
 GN 3975-20-A-12-18-AN

Measures



$b_1 = 35$	gear ratio= $i = 18$	$t_2 = 13.8$
$b_2 = 4$	$h = 1.5$	$t_3 = 1.6$
$b_3 = 4$	$l_1 = 60$	$t_4 = 18.3$
$d_1 = 12$	$l_2 = 16$	weight (g) = 426
$d_2 = 12$	$l_3 = 12$	
$d_3 = 30$	$l_4 = 3$	
$d_4 = 20$	$m_1 = 20$	
$d_5 = 27.4$	$t_1 = 2$	